

Plan 1- Base Frame

Designed by Josh Byrne, Drawn by Gary James 2005

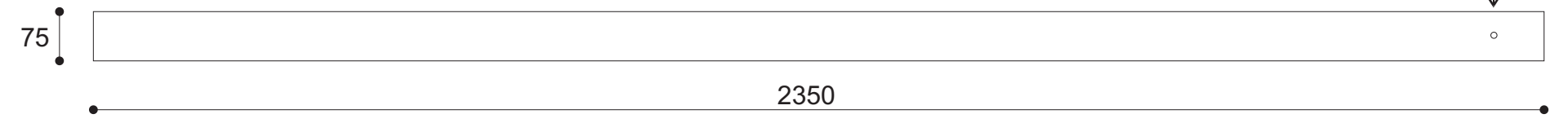
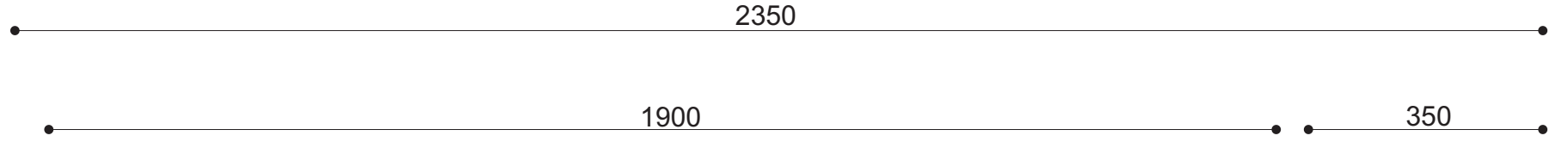
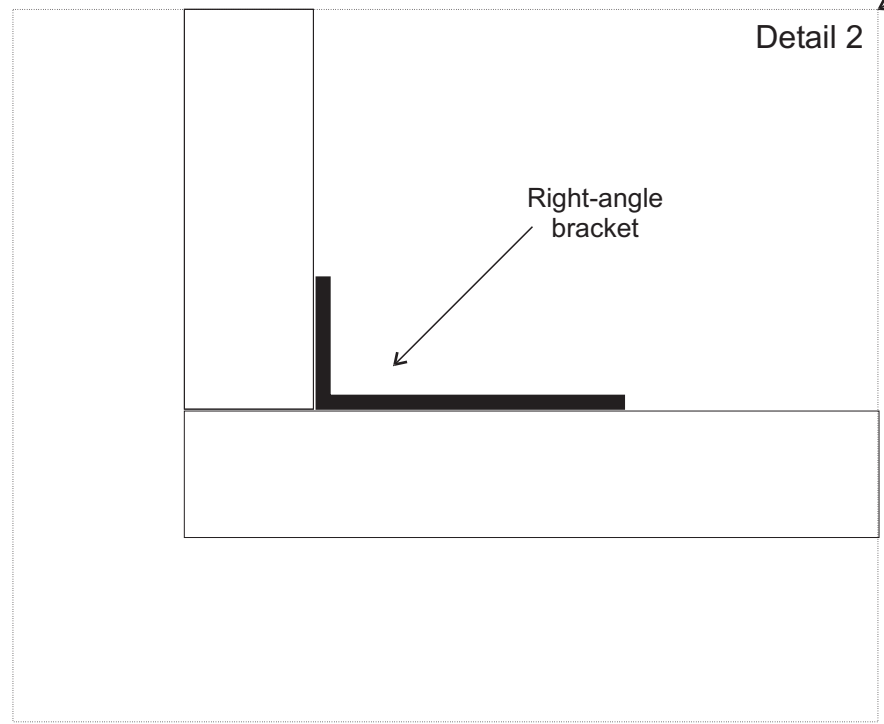
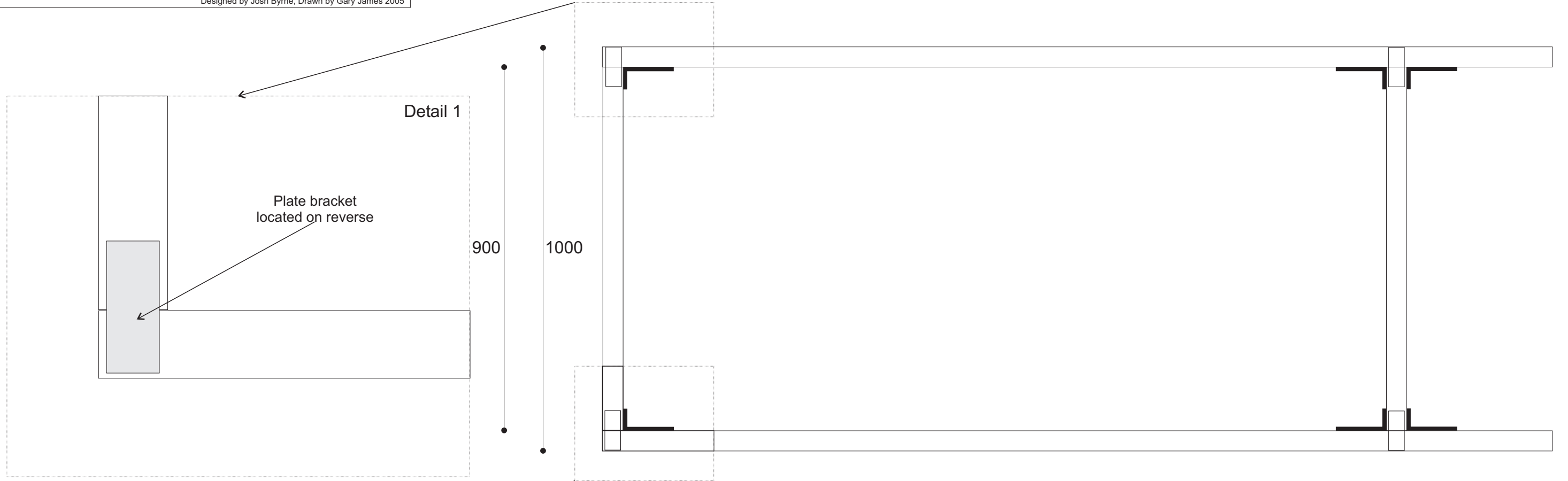

Plan 2 - A-Frames

Designed by Josh Byrne, Drawn by Gary James 2005

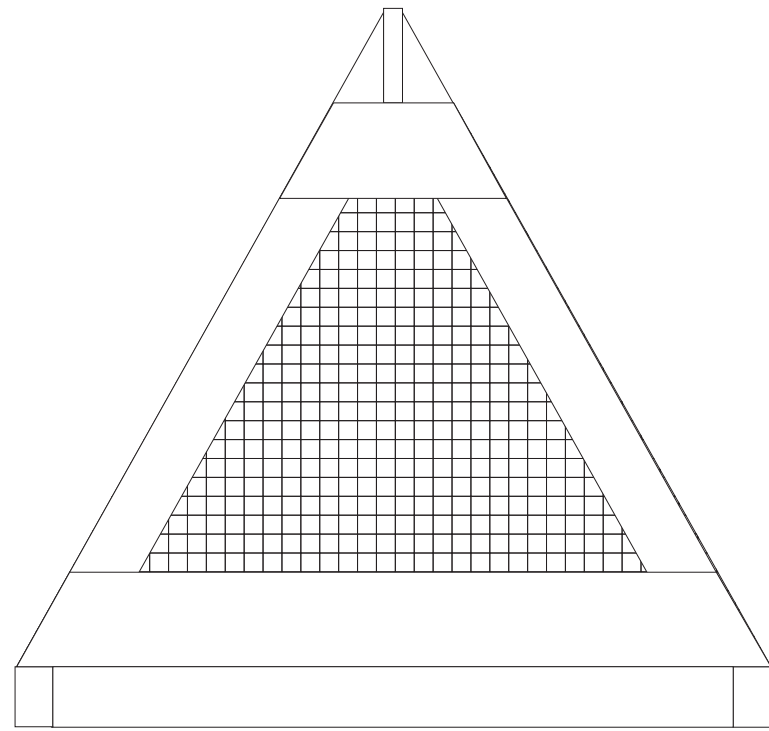

Front



1000

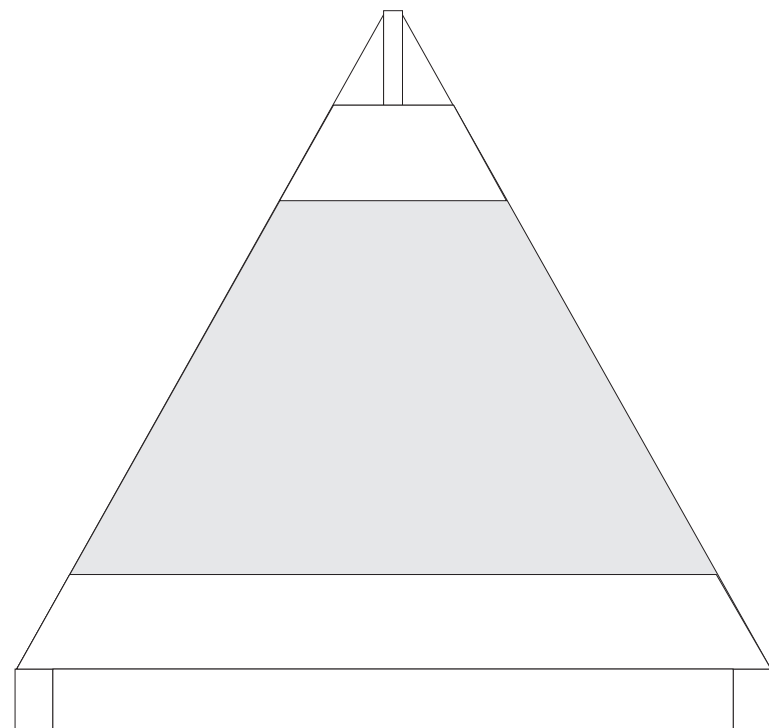

Rear

950

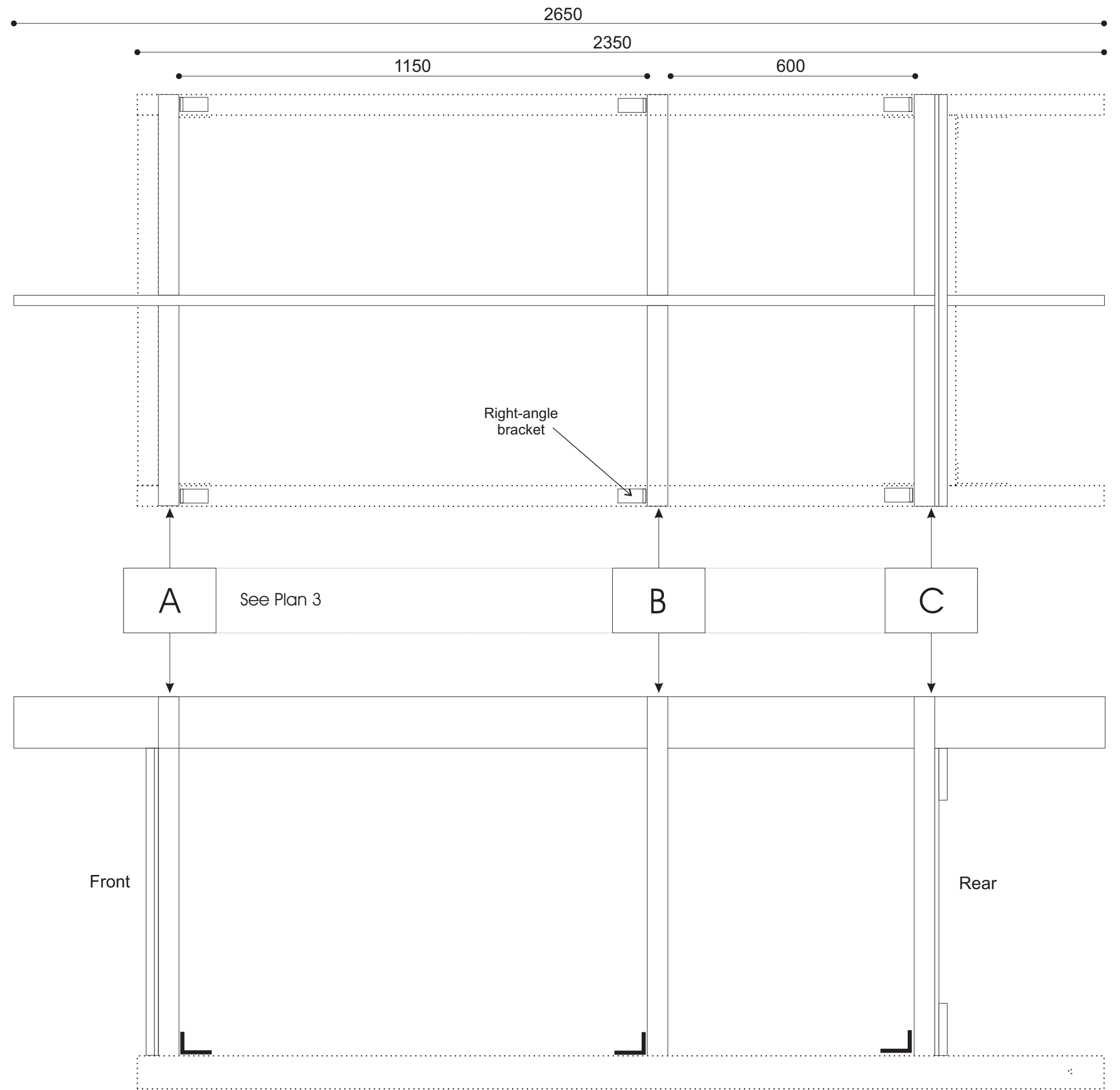

Right-angle
bracket

A

See Plan 3

B

C

Front

Rear

0 500
MILLIMETRES

Plan 3 - A-Frames

Designed by Josh Byrne, Drawn by Gary James 2005



Upper Brace

A

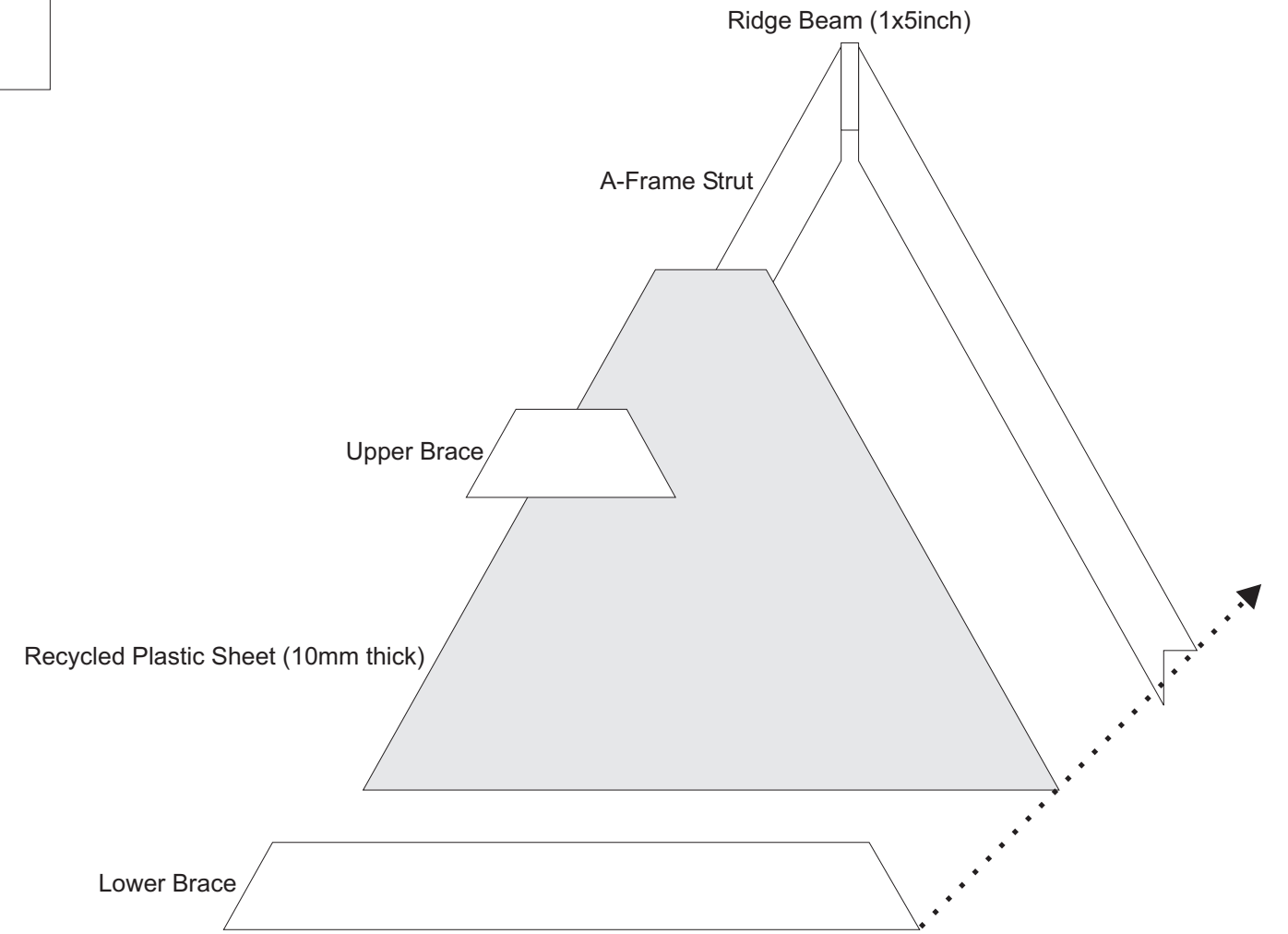

B

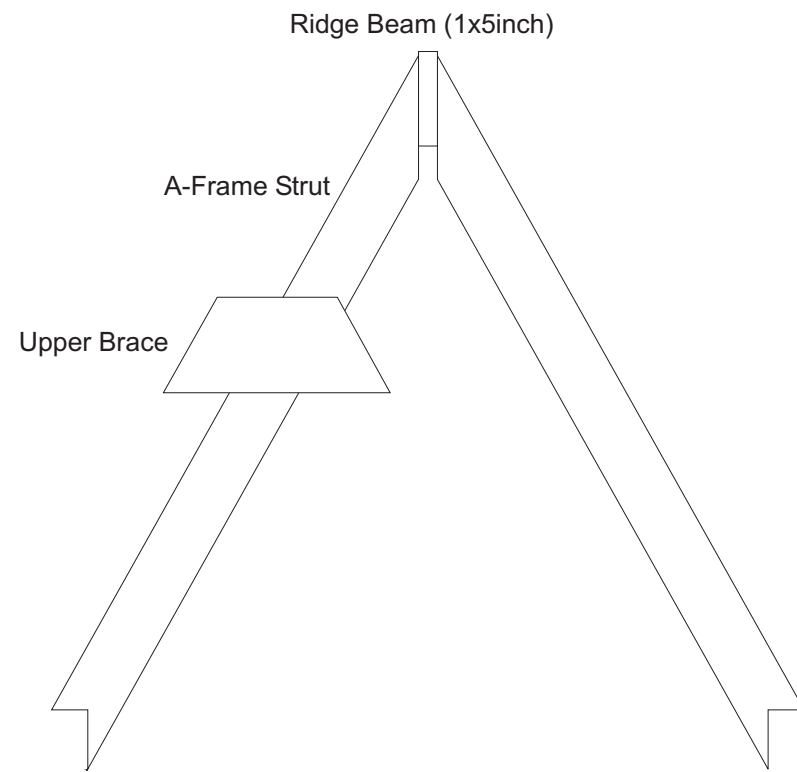

C

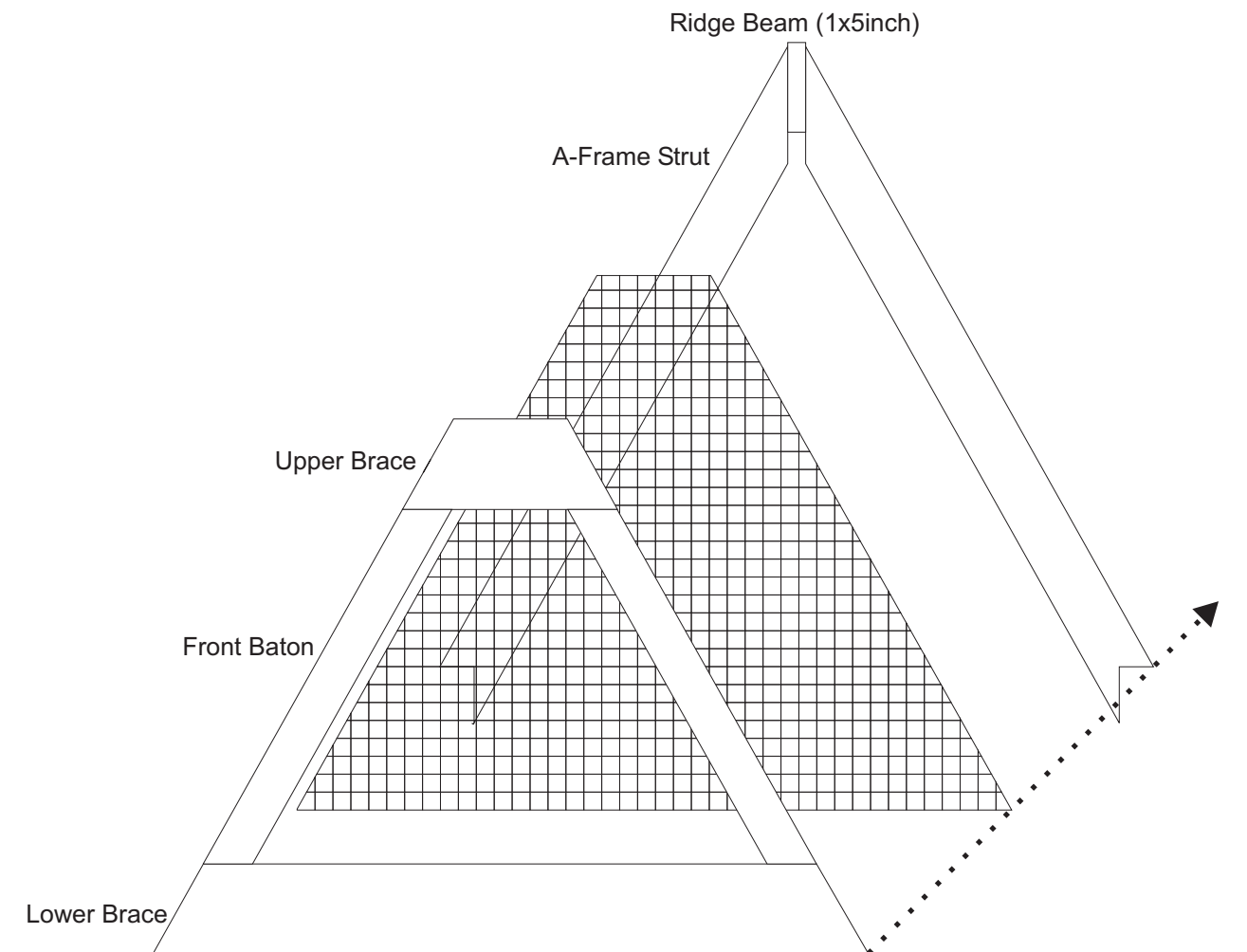

Plan 4 - Mesh/Cladding

Designed by Josh Byrne, Drawn by Gary James 2005

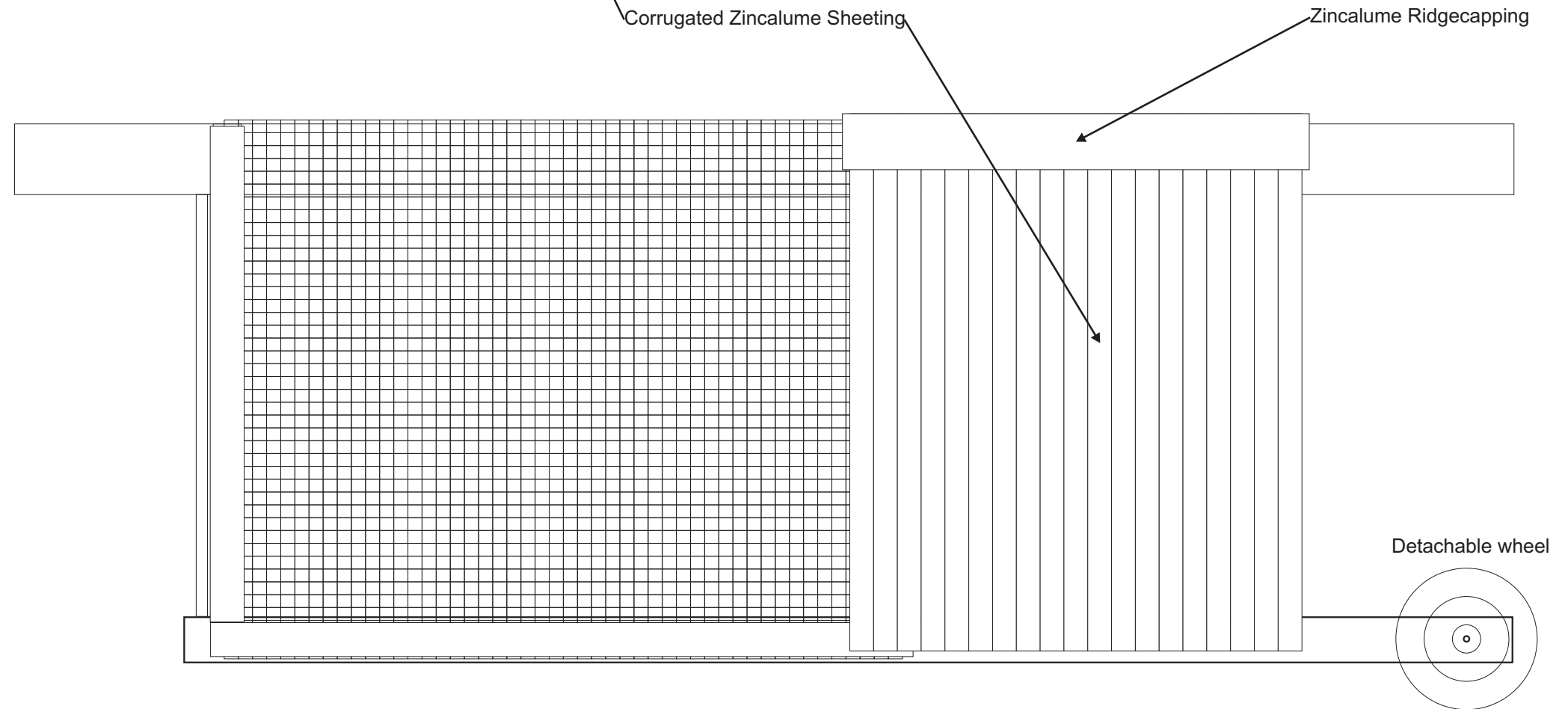
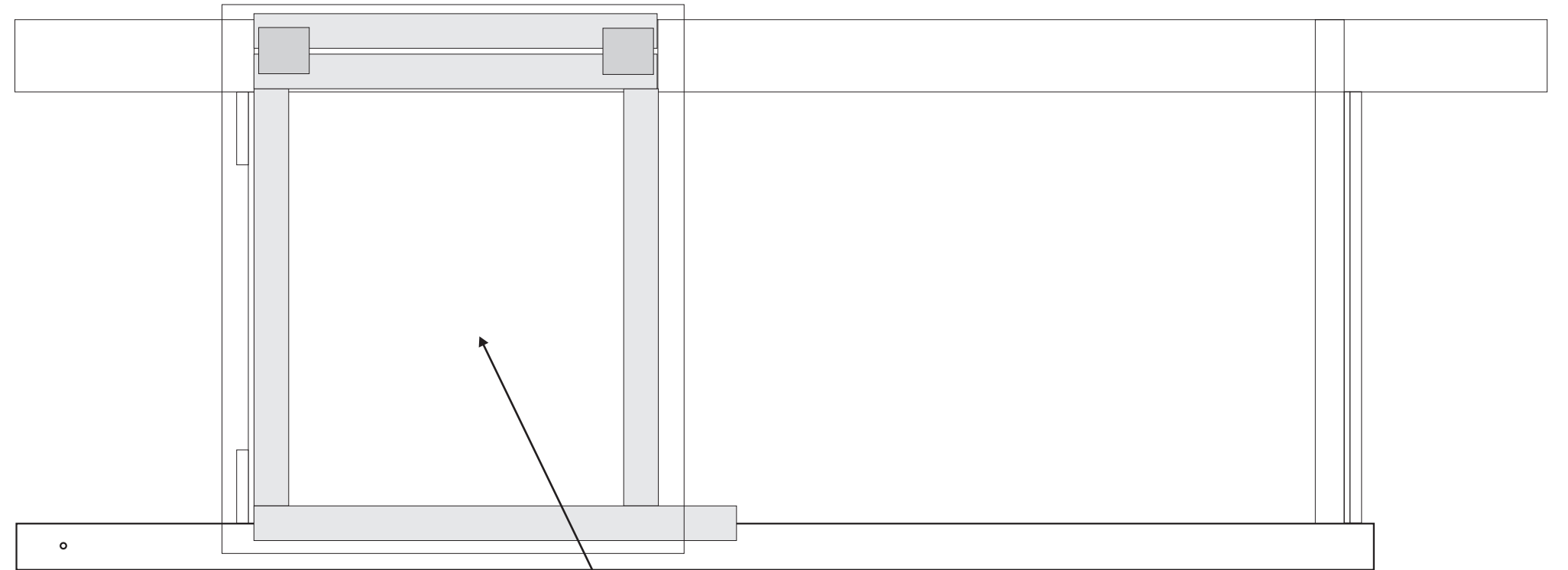
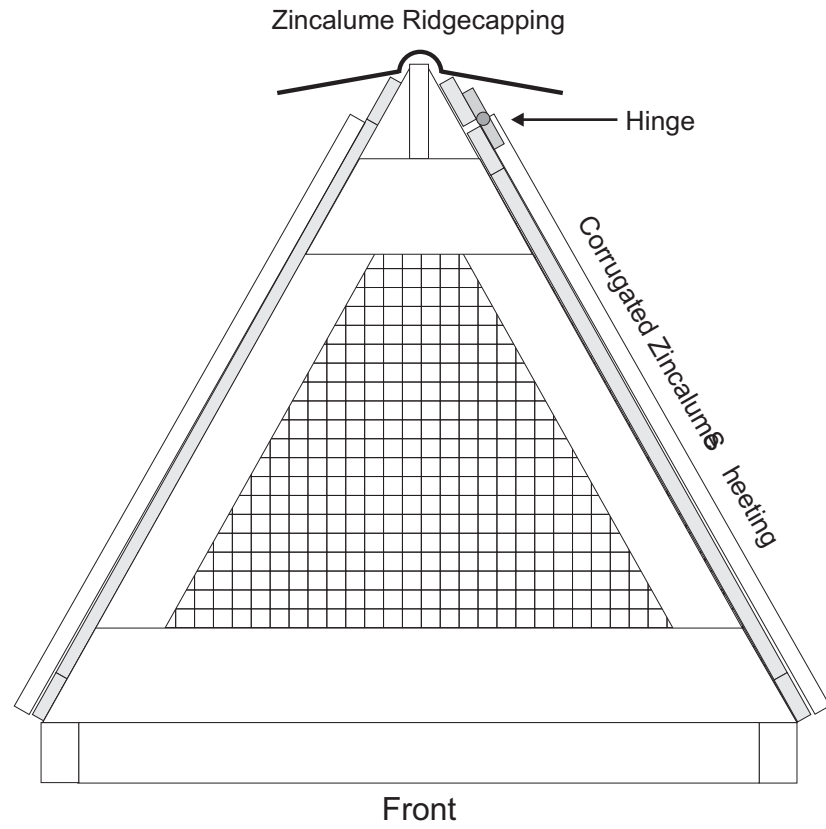

Plan 5 - Parts List A

Designed by Josh Byrne, Drawn by Gary James 2005

NOTE: Lengths are approximate and will depend on type of recycled wood used

Ridge Beam (1)
- 1x5inch x 2650mm



Base Frame Long (2)
- 3x2inch x 2350mm



Base Frame Short (2)
- 3x2inch x 900mm



A-Frame Struts (6)
- 3x2inch x 1050mm



Lower Brace (2)
- 1x5inch x 1000mm



Upper Brace (3)
- 1x5inch x 300mm



Front Batons (2)
- 2x0.75inch x 600mm



Perch/Access Hatch Stand (1)
- 40x40mm x 900mm



Horizontal Hatch Batons (5)
- 2x0.75inch x 700mm

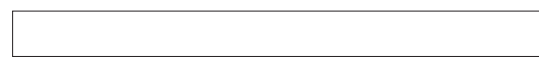

Vertical Hatch Batons (2)
- 2x0.75inch x 750mm



Horizontal Batons Securing Mesh (2)
- 2x0.75inch x 1200mm



Vertical Batons Securing Mesh (2)
- 2x0.75inch x 900mm



Plan 6 - Parts List B

Designed by Josh Byrne, Drawn by Gary James 2005

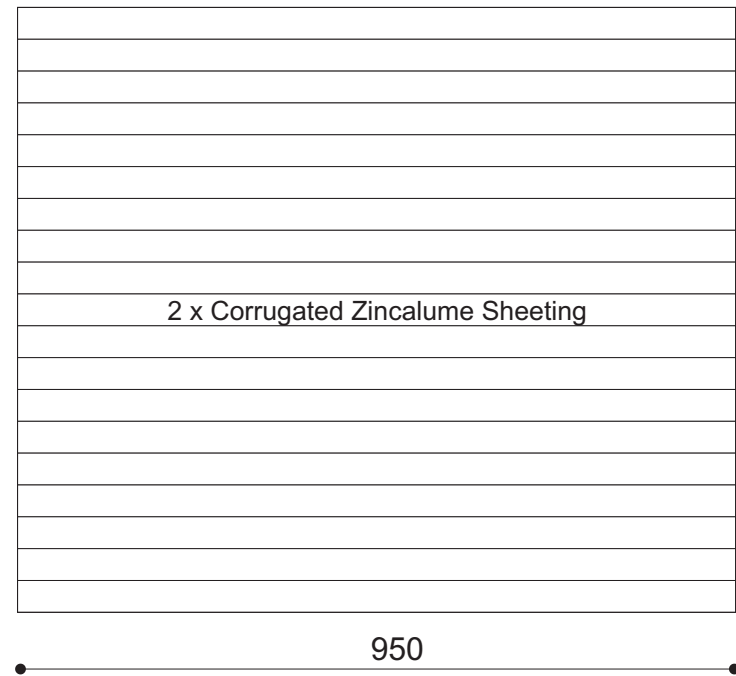
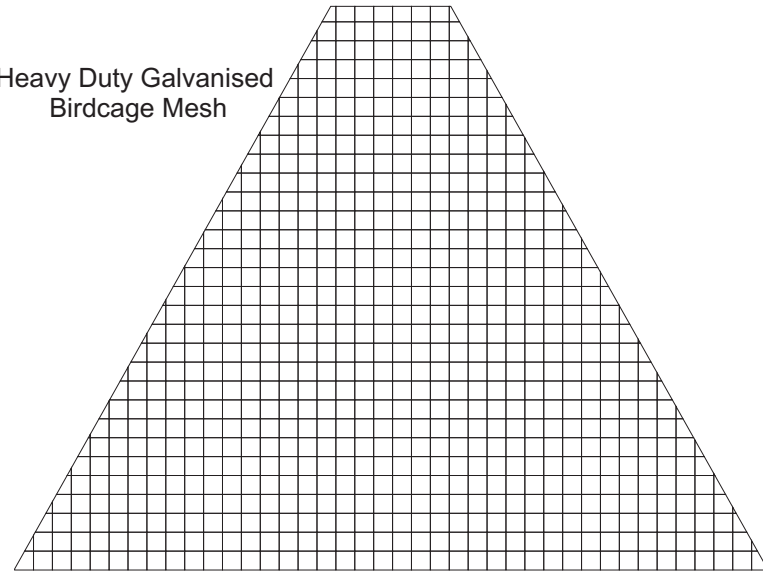
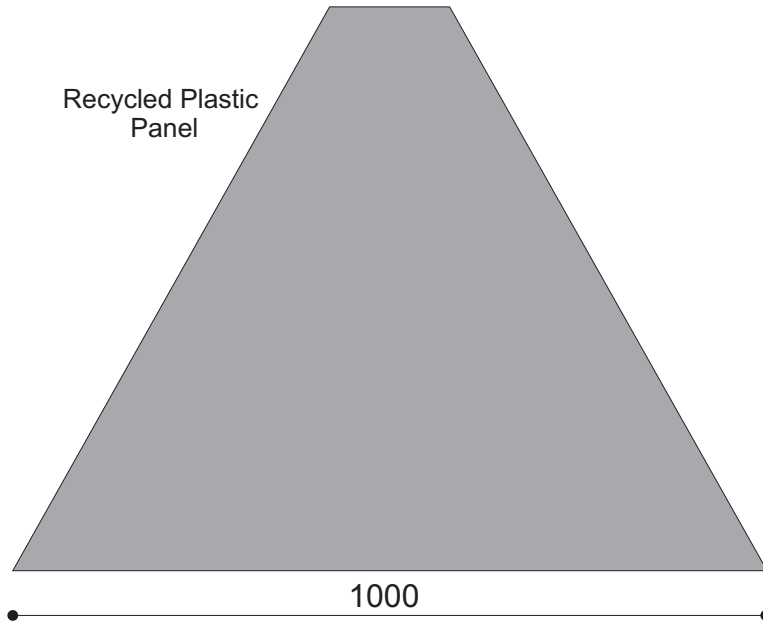

Zincolume Ridgescaping

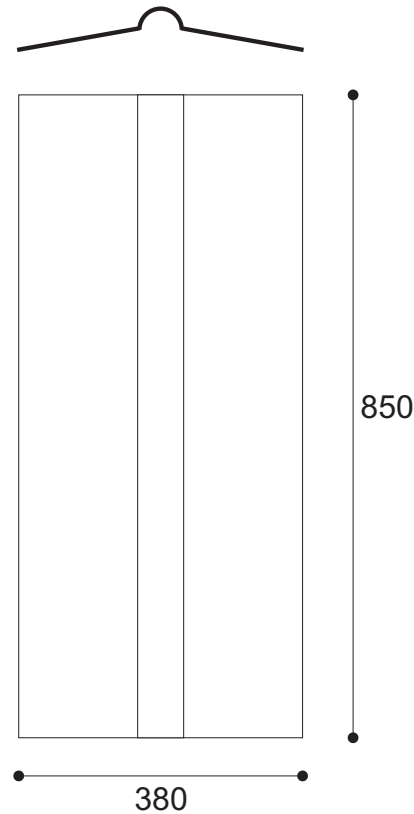

2 x 10inch Tyre

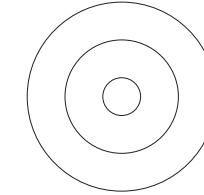

4 x Plate Bracket

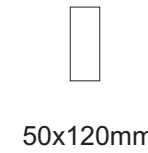

6 x Long Right-Angle Bracket



6 x Short Right-Angle Bracket



Heavy Duty Galvanised Birdcage Mesh

